

# visual elements

We work closely with designers and architects to create quality consumer environments and develop new products and finishes to meet the demands of a globally competitive retail sector.

From full retail environments, to a simple visual display, the best work is the only work we do. Our goal is to support our partners' brands by creating exceptional retail environments through advanced technology and superior craftsmanship.

Visual Elements brings a seasoned yet innovative approach to retail design, branding, engineering and manufacturing. With over 30 years of experience, we're ready to take your business to new heights.

# contents

# the **module** system



The Module System is our proprietary fixture display collection.

Our pre-engineered modules are designed specifically for any retail experience and can be configured to infinity and beyond. We create environments using materials and finishes that are unique to your brand, while improving speed to market. Proudly designed and built by Visual Elements.

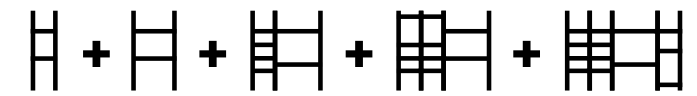



# design programs



HOW IT WORKS

# à la carte

PROGRAM

If you already have an established shop and just need a few display fixtures, or need help with a new floor plan layout, the à la Carte Program is for you.

We'll use the Module System along with your floor plan and brand identity to fill the holes.

## THIS PROGRAM INCLUDES:

- Floor plan layout
- The Module System fixture plan

POWDER COATS  
white, black or grey



LAMINATES  
maple, oak, walnut, black or white



*NOTE*  
Fixtures shown in white powder coat with maple laminate.



# custom module

PROGRAM

If you need a complete store design, but are short on time and working with a modest budget, the Custom Program is for you.

Using the Module System, provide us with your vision of the space and we'll create a custom design that speaks to your brand ethos.

## THIS PROGRAM INCLUDES:

- Custom design concept with mood board & design direction
- Floor plan layout and elevations
- The Module System fixture plan with custom colour and finish
- Decorative lighting plan
- 3D renderings of your design



# wall system



COMPONENTS



WALL SYSTEM

# frames

## 24" WIDE FRAME

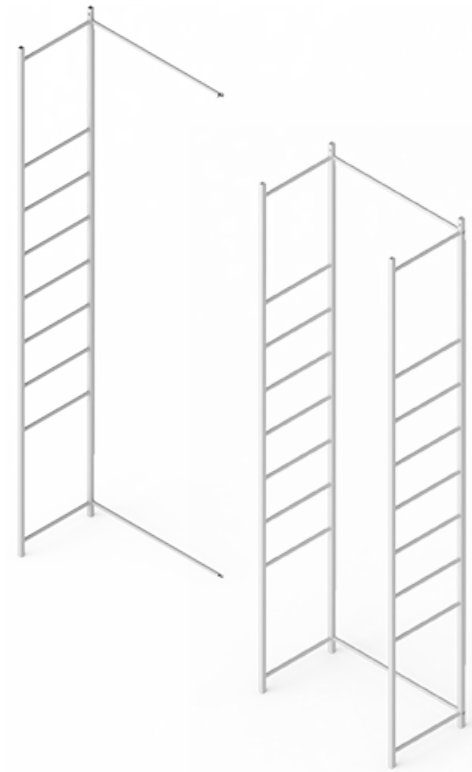

24" 1 BAY WALL FRAME  
24.75"W X 15.75"D X 84"H  
70-00001-00000000040

24" ADD-ON WALL FRAME  
50.25"W X 15.75"D X 84"H  
70-00296-00000000040

## 36" WIDE FRAME

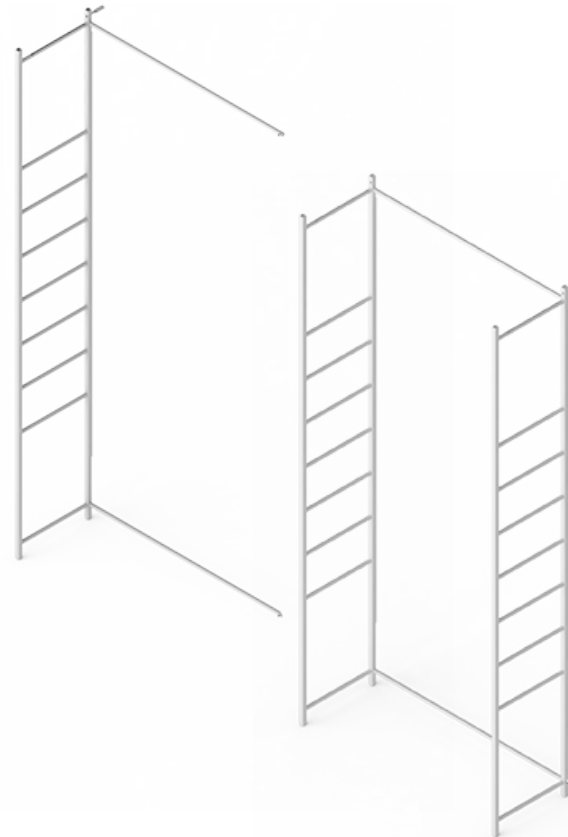

36" 1 BAY WALL FRAME  
36.75"W X 15.75"D X 84"H  
70-00007-00000000040

36" ADD-ON WALL FRAME  
73.75"W X 15.75"D X 84"H  
70-00297-00000000040

## 48" WIDE FRAME

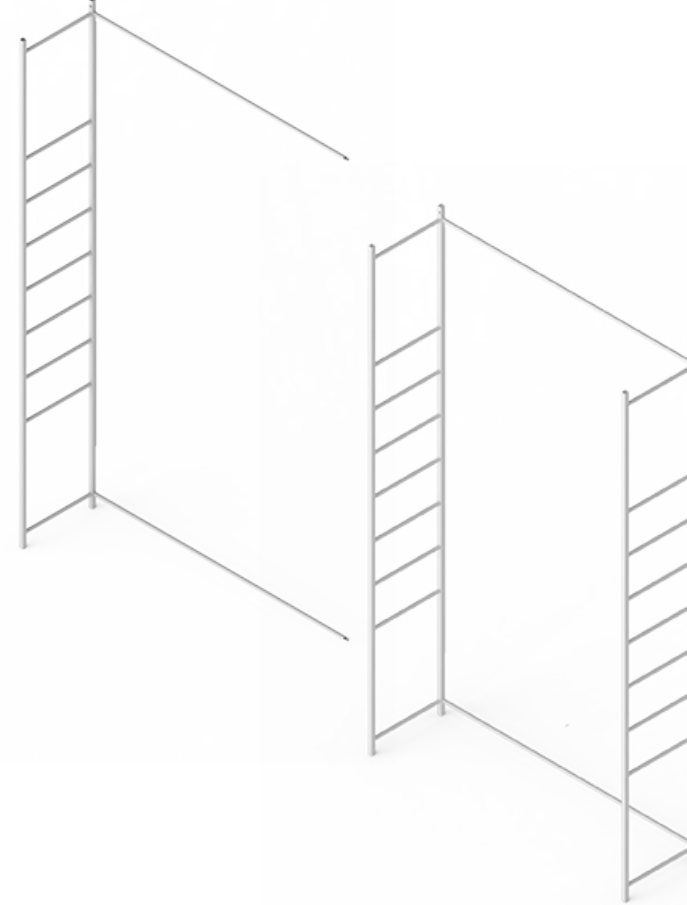

48" 1 BAY WALL FRAME  
48.75"W X 15.75"D X 84"H  
70-00102-00000000040

48" ADD-ON WALL FRAME  
98.25"W X 15.75"D X 84"H  
70-00298-00000000040

## SIDE GABLE

SIDE GABLES ARE REQUIRED ON THE EXTREME ENDS OF WALL FRAMES WHEN USING HEADERS

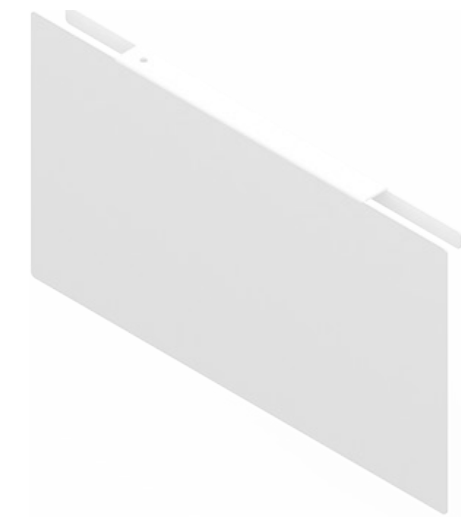

SHORT WALL FRAME SIDE GABLE  
13"W X .825"D X 7"H  
70-00098-00000000040

TALL WALL FRAME SIDE GABLE  
13"W X .825"D X 14"H  
70-00295-00000000040

WALL SYSTEM

# shelves

● 24" WIDE SHELF



24" WOOD SHELF CAP  
23.75"W X 13.375"D X 1.5"H  
70-00013-00000000020

● 36" WIDE SHELF



36" WOOD SHELF CAP  
35.75"W X 13.375"D X 1.5"H  
70-00015-00000000020

● 48" WIDE SHELF



48" WOOD SHELF CAP  
47.75"W X 13.375"D X 1.5"H  
70-00109-00000000020



24" METAL WALL SHELF  
23.875"W X 13.875"D X .5"H  
70-00014-00000000040



36" METAL WALL SHELF  
37.875"W X 13.875"D X .5"H  
70-00016-00000000040



48" METAL WALL SHELF  
47.875"W X 13.875"D X .5"H  
70-00110-00000000040

WALL SYSTEM

# shelves

● 24" WIDE SHALLOW SHELF



24" WOOD SHELF CAP SHALLOW  
23.75"W X 8.25"D X 1.5"H  
70-00320-00000000020

● 36" WIDE SHALLOW SHELF



36" WOOD SHELF CAP SHALLOW  
23.75"W X 8.25"D X 1.5"H  
70-00322-00000000020

● 48" WIDE SHALLOW SHELF



48" WOOD SHELF CAP SHALLOW  
23.75"W X 8.25"D X 1.5"H  
70-00324-00000000020



24" METAL WALL SHELF SHALLOW  
23.875"W X 7.75"D X .5"H  
70-00321-00000000040



36" METAL WALL SHELF SHALLOW  
23.875"W X 8.25"D X .5"H  
70-00323-00000000040

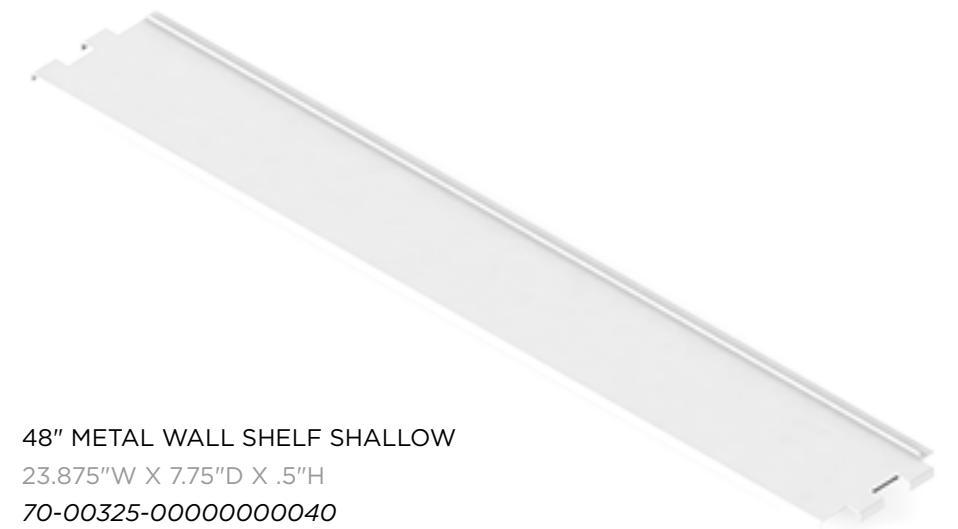

48" METAL WALL SHELF SHALLOW  
23.875"W X 7.75"D X .5"H  
70-00325-00000000040

WALL SYSTEM

# shelves

● SHELVES WITH GARMENT ROD

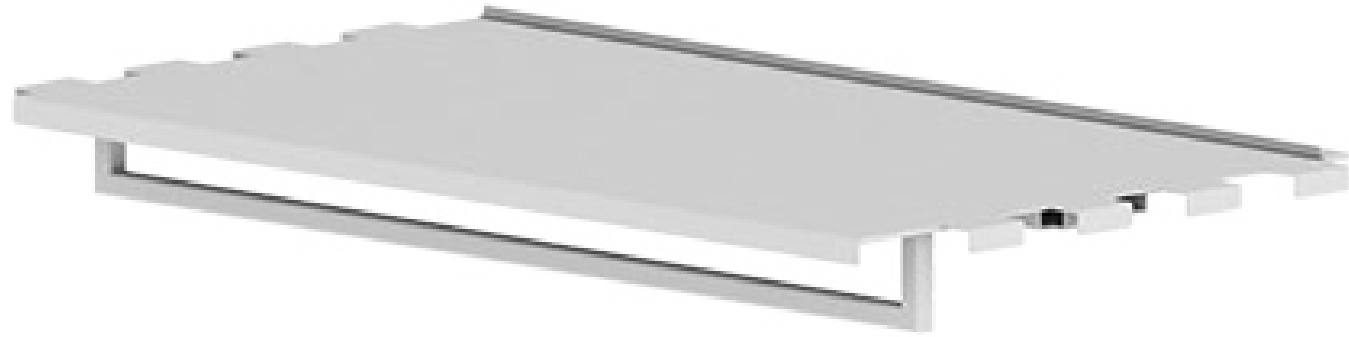

24" METAL WALL SHELF WITH GARMENT ROD  
23.875"W X 13.875"D X 3"H  
70-00267-00000000040

36" METAL WALL SHELF WITH GARMENT ROD  
37.875"W X 13.875"D X 3"H  
70-00268-00000000040

48" METAL WALL SHELF WITH GARMENT ROD  
47.875"W X 13.875"D X 3"H  
70-00316-00000000040

● SHELVES WITH GARMENT ROD - FRONT FACING



24" METAL WALL SHELF WITH GARMENT ROD - FRONT FACING  
23.875"W X 13.875"D X 6.25"H  
70-00317-00000000040

36" METAL WALL SHELF WITH GARMENT ROD - FRONT FACING  
37.875"W X 13.875"D X 6.25"H  
70-00318-00000000040

48" METAL WALL SHELF WITH GARMENT ROD - FRONT FACING  
47.875"W X 13.875"D X 6.25"H  
70-00319-00000000040

WALL SYSTEM

# display boxes

● 24" WIDE DISPLAY BOXES



RIGHT OPENING SHOWN

24" 1-DOOR SHORT DISPLAY BOX  
LEFT OPENING  
23.75"W X 12.5"D X 12.5"H  
70-00111-00000000063

24" 1-DOOR SHORT DISPLAY BOX  
RIGHT OPENING  
23.75"W X 12.5"D X 12.5"H  
70-00019-00000000063

24" 1-DOOR MEDIUM DISPLAY BOX  
LEFT OPENING  
23.75"W X 12.5"D X 17"H  
70-00112-00000000063

24" 1-DOOR MEDIUM DISPLAY BOX  
RIGHT OPENING  
23.75"W X 12.5"D X 19.5"H  
70-00020-00000000063

24" 1-DOOR TALL DISPLAY BOX  
LEFT OPENING  
23.75"W X 12.5"D X 32"H  
70-00113-00000000063

24" 1-DOOR TALL DISPLAY BOX  
RIGHT OPENING  
23.75"W X 12.5"D X 32"H  
70-00021-00000000063

24" 1-DOOR EXTRA-TALL DISPLAY BOX  
LEFT OPENING  
23.75"W X 12.5"D X 46.5"H  
70-00293-00000000063

24" 1-DOOR EXTRA-TALL DISPLAY BOX  
RIGHT OPENING  
23.75"W X 12.5"D X 46.5"H  
70-00292-00000000063

● 36" WIDE DISPLAY BOXES



36" 2-DOOR SHORT DISPLAY BOX  
35.75"W X 12.5"D X 12.5"H  
70-00022-00000000063

36" 2-DOOR MEDIUM DISPLAY BOX  
35.75"W X 12.5"D X 19.5"H  
70-00023-00000000063

36" 2-DOOR TALL DISPLAY BOX  
35.75"W X 12.5"D X 32"H  
70-00024-00000000063

36" 2-DOOR EXTRA-TALL DISPLAY BOX  
35.75"W X 12.5"D X 46.5"H  
70-00294-00000000063

WALL SYSTEM

# drawers

## 24" WIDE DRAWERS



24" 1-DRAWER CABINET  
23.75"W X 12.5"D X 17.25"H  
70-00039-00000000061

## 36" WIDE DRAWERS



36" 1-DRAWER CABINET  
35.75"W X 12.5"D X 17.5"H  
70-00040-00000000061

## 48" WIDE DRAWERS



48" 2-DRAWER CABINET  
47.75"W X 12.5"D X 17.5"H  
70-00120-00000000060

## BASES

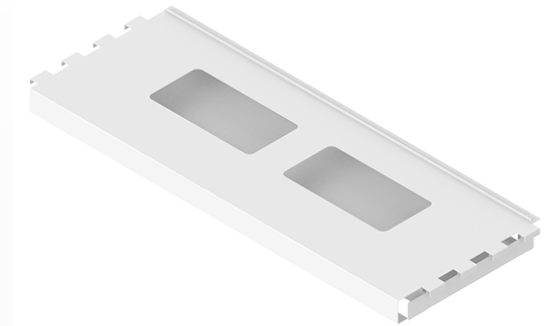

24" METAL WALL BASE SHELF  
23.875"W X 13.875"D X .2"H  
70-00289-00000000040



24" 2-DRAWER CABINET  
23.75"W X 12.5"D X 31.75"H  
70-00118-00000000061



36" 2-DRAWER CABINET  
35.75"W X 12.5"D X 31.75"H  
70-00119-00000000061



48" 4-DRAWER CABINET  
47.75"W X 12.5"D X 31.75"H  
70-00121-00000000060

36" METAL WALL BASE SHELF  
37.875"W X 13.875"D X 2"H  
70-00290-00000000040

48" METAL WALL BASE SHELF  
47.875"W X 13.875"D X 2"H  
70-00302-00000000040

WALL SYSTEM

# cabinets

## 24" WIDE CABINETS



24" 1-DOOR SHORT CABINET  
LEFT OPENING  
23.75"W X 12.5"D X 17.5"H  
70-00114-00000000061

24" 1-DOOR TALL CABINET  
LEFT OPENING  
23.75"W X 12.5"D X 31.75"H  
70-00115-00000000061

RIGHT OPENING SHOWN

24" 1-DOOR SHORT CABINET  
RIGHT OPENING  
23.75"W X 12.5"D X 17.5"H  
70-00035-00000000061

24" 1-DOOR TALL CABINET  
RIGHT OPENING  
23.75"W X 12.5"D X 31.75"H  
70-00036-00000000061

## 36" WIDE CABINETS



36" 2-DOOR SHORT CABINET  
35.75"W X 12.5"D X 17.5"H  
70-00037-00000000061

36" 2-DOOR TALL CABINET  
35.75"W X 12.5"D X 31.75"H  
70-00038-00000000061

## 48" WIDE CABINETS



48" 2-DOOR SHORT CABINET  
47.75"W X 12.5"D X 17.5"H  
70-00116-00000000060

48" 2-DOOR TALL CABINET  
47.75"W X 12.5"D X 31.75"H  
70-00117-00000000060

WALL SYSTEM

# graphic headers

● 24" WIDE HEADERS

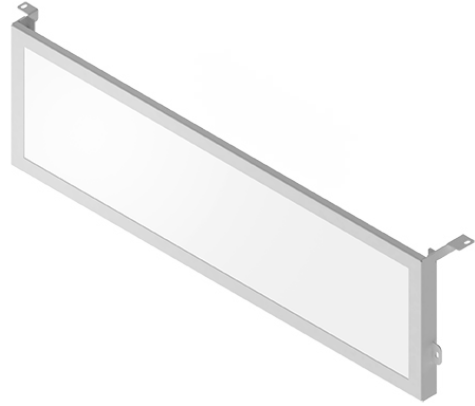

24" SHORT HEADER  
25.125"W X 1"D X 7.125"H  
70-00045-00000000042

24" TALL HEADER  
25.125"W X 1"D X 14.125"H  
70-00046-00000000042

● 36" WIDE HEADERS

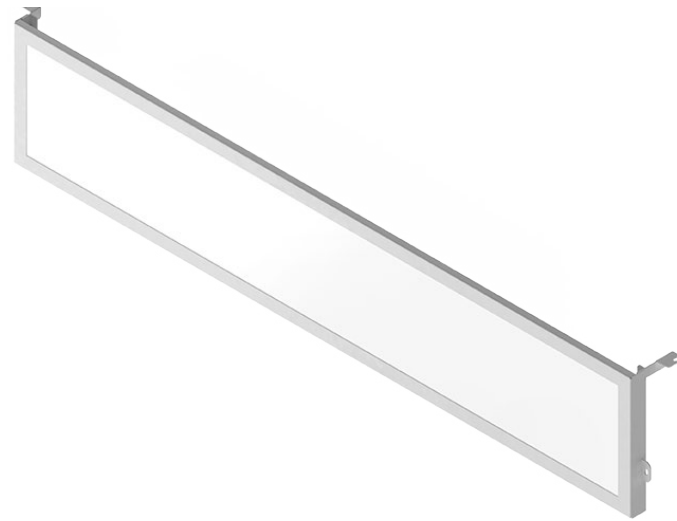

36" SHORT HEADER  
37.125"W X 1"D X 7.125"H  
70-00047-00000000042

36" TALL HEADER  
37.125"W X 1"D X 14.125"H  
70-00048-00000000042

● 48" WIDE HEADERS



48" SHORT HEADER  
39.125"W X 1"D X 7.125"H  
70-00127-00000000040

48" TALL HEADER  
39.125"W X 1"D X 14.125"H  
70-00127-00000000040

**LIGHT RAILS**

24" LIGHT RAIL  
25.125"W X 1"D X .5"H  
70-00124-00000000040

36" LIGHT RAIL  
37.125"W X 1"D X .5"H  
70-00125-00000000040

48" LIGHT RAIL  
39.125"W X 1"D X .5"H  
70-00128-00000000040





# table system



COMPONENTS

TABLE SYSTEM

# tables

## 24" WIDE TABLES



2'X2' STANDARD TABLE  
24"W X 25.5"L X 36"H  
70-00053-00000000060

2'X3' STANDARD TABLE  
24"W X 37.5"L X 36"H  
70-00054-00000000060

2'X4' STANDARD TABLE  
24"W X 49.5"L X 36"H  
70-00153-00000000060



2'X6' STANDARD TABLE  
24"W X 73.5"L X 36"H  
70-00055-00000000060

2'X8' STANDARD TABLE  
24"W X 97.5"L X 36"H  
70-00056-00000000060

## 36" WIDE TABLES



3'X2' STANDARD TABLE  
36"W X 25.5"L X 36"H  
70-00057-00000000060

3'X3' STANDARD TABLE  
36"W X 37.5"L X 36"H  
70-00058-00000000060

3'X4' STANDARD TABLE  
36"W X 49.5"L X 36"H  
70-00154-00000000060



3'X6' STANDARD TABLE  
36"W X 73.5"L X 36"H  
70-00059-00000000060

3'X8' STANDARD TABLE  
36"W X 97.5"L X 36"H  
70-00060-00000000060

TABLE SYSTEM

# tables

## 24" WIDE TABLES WITH DRAWER

DRAWERS ON ONE SIDE OF UNIT



2'X2' TABLE WITH DRAWER

24"W X 25.5"L X 36"H

70-00162-00000000060

2'X3' TABLE WITH DRAWER

24"W X 37.5"L X 36"H

70-00162-00000000060

2'X4' TABLE WITH DRAWER

24"W X 49.5"L X 36"H

70-00164-00000000060



2'X6' TABLE WITH DRAWERS

24"W X 73.5"L X 36"H

70-00165-00000000060

2'X8' TABLE WITH DRAWERS

24"W X 97.5"L X 36"H

70-00166-00000000060

## 36" WIDE TABLES WITH DRAWERS

DRAWERS ON BOTH SIDES OF UNIT



3'X2' TABLE WITH DRAWER

36"W X 25.5"L X 36"H

70-00167-00000000060

3'X3' TABLE WITH DRAWER

36"W X 37.5"L X 36"H

70-00168-00000000060

3'X4' TABLE WITH DRAWER

36"W X 49.5"L X 36"H

70-00169-00000000060

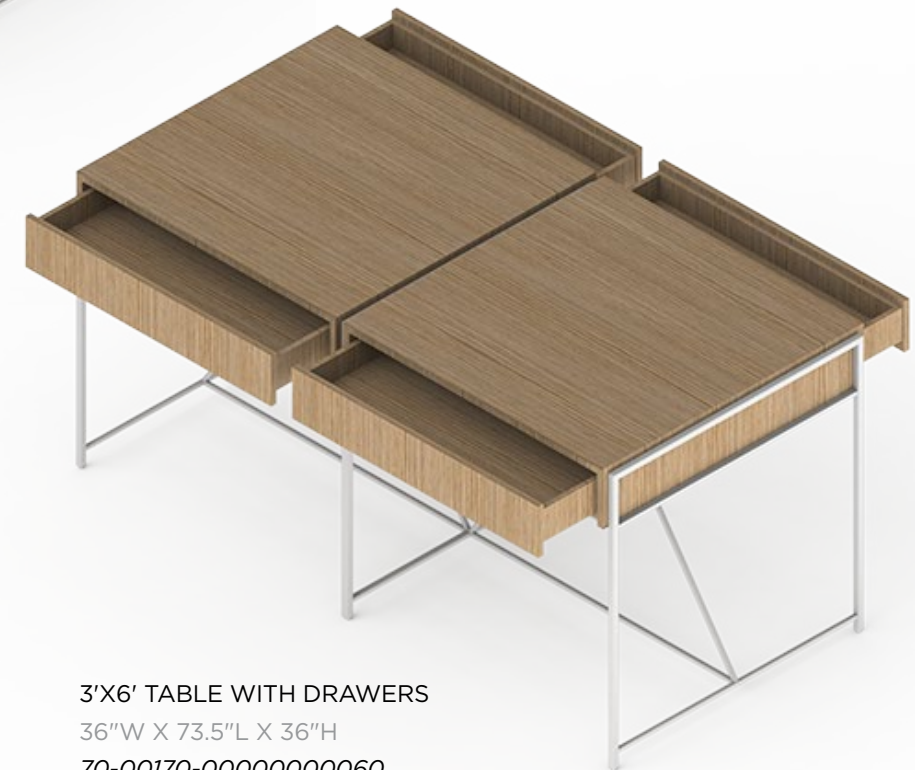

3'X6' TABLE WITH DRAWERS

36"W X 73.5"L X 36"H

70-00170-00000000060

3'X8' TABLE WITH DRAWERS

36"W X 97.5"L X 36"H

70-00171-00000000060

TABLE SYSTEM

# tables

● 24" WIDE DISPLAY BOX TABLES



2'X2' DISPLAY BOX TABLE  
24"W X 25.5"L X 36"H  
70-00061-00000000060

2'X3' DISPLAY BOX TABLE  
24"W X 37.5"L X 36"H  
70-00062-00000000060

2'X4' DISPLAY BOX TABLE  
24"W X 49.5"L X 36"H  
70-00155-00000000060



2'X6' DISPLAY BOX TABLE  
24"W X 73.5"L X 36"H  
70-00063-00000000060

2'X8' DISPLAY BOX TABLE  
24"W X 97.5"L X 36"H  
70-00064-00000000060

● 36" WIDE DISPLAY BOX TABLES



3'X2' DISPLAY BOX TABLE  
36"W X 25.5"L X 36"H  
70-00065-00000000060

3'X3' DISPLAY BOX TABLE  
36"W X 37.5"L X 36"H  
70-00066-00000000060

3'X4' DISPLAY BOX TABLE  
36"W X 49.5"L X 36"H  
70-00156-00000000060



3'X6' DISPLAY BOX TABLE  
36"W X 73.5"L X 36"H  
70-00067-00000000060

3'X8' DISPLAY BOX TABLE  
36"W X 97.5"L X 36"H  
70-00068-00000000060

TABLE SYSTEM

# impulse bin

12" WIDE IMPULSE BIN



1'X2' TABLE IMPULSE BIN  
12"W X 25.5"L X 36"H  
70-00069-000000000060

1'X3' TABLE IMPULSE BIN  
12"W X 37.5"L X 36"H  
70-00070-000000000060

1'X4' TABLE IMPULSE BIN  
12"W X 49.5"L X 36"H  
70-00071-000000000060

TABLE SYSTEM

# glass vitrines

● VITRINES FOR 12" WIDE UNITS



1'X2' SHORT VITRINE  
12"W X 21"L X 7"H  
70-00027-00000000040

1'X3' SHORT VITRINE  
12"W X 33"L X 7"H  
70-00029-00000000040

1'X2' TALL VITRINE  
12"W X 21"L X 12.5"H  
70-00028-00000000040

1'X3' TALL VITRINE  
12"W X 33"L X 12.5"H  
70-00030-00000000040

● VITRINES FOR 24" WIDE UNITS

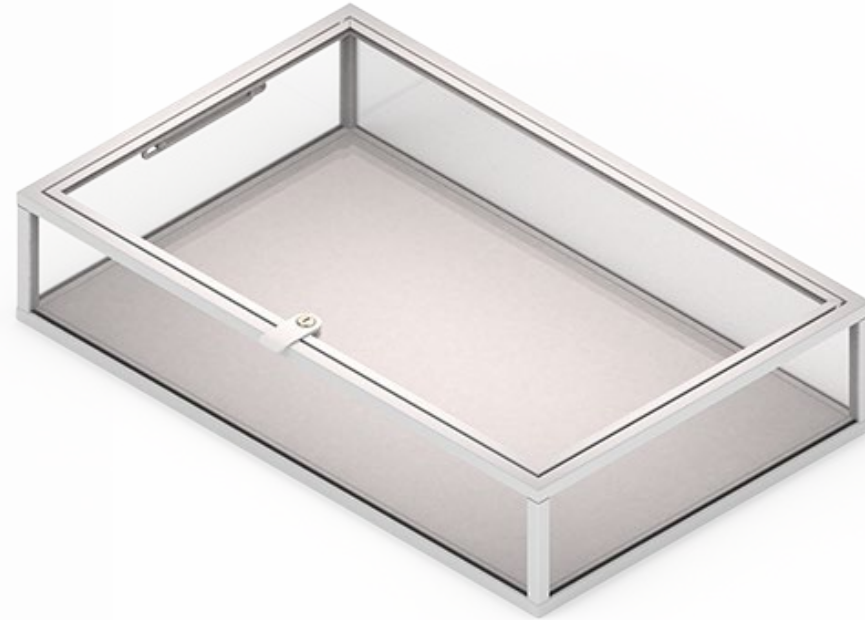

2'X2' SHORT VITRINE  
21"W X 21"L X 7"H  
70-00072-00000000060

2'X3' SHORT VITRINE  
21"W X 33"L X 7"H  
70-00073-00000000060

2'X4' SHORT VITRINE  
21"W X 45"L X 7"H  
70-00074-00000000060

2'X2' TALL VITRINE  
21"W X 21"L X 12.5"H  
70-00157-00000000060

2'X3' TALL VITRINE  
21"W X 33"L X 12.5"H  
70-00158-00000000060

2'X4' TALL VITRINE  
21"W X 45"L X 12.5"H  
70-00159-00000000060

● VITRINES FOR 36" WIDE UNITS



3'X3' SHORT VITRINE  
33"W X 33"L X 7"H  
70-00075-00000000060

3'X4' SHORT VITRINE  
33"W X 45"L X 7"H  
70-00076-00000000060

3'X3' TALL VITRINE  
33"W X 33"L X 12.5"H  
70-00160-00000000060

3'X4' TALL VITRINE  
33"W X 45"L X 12.5"H  
70-00161-00000000060



# p.o.s + back wrap system



COMPONENTS

P.O.S  
**cabinets**

**POINT-OF-SALE CABINETS**



36" P.O.S CABINET  
36"W X 23.25"D X 35.5"H  
70-00216-00000000060

24" P.O.S CABINET  
24"W X 23.25"D X 35.5"H  
70-00215-00000000060

**1-DOOR CABINETS**



12" STORAGE CABINET, 1-DOOR, RIGHT OPENING  
12"W X 23.25"D X 35.5"H  
70-00217-00000000060

12" STORAGE CABINET, 1-DOOR, LEFT OPENING  
12"W X 23.25"D X 35.5"H  
70-00218-00000000060

24" STORAGE CABINET, 1-DOOR, RIGHT OPENING  
24"W X 23.25"D X 35.5"H  
70-00219-00000000060

24" STORAGE CABINET, 1-DOOR, LEFT OPENING  
24"W X 23.25"D X 35.5"H  
70-00220-00000000060

**2-DOOR CABINET**



36" 2-DOOR STORAGE CABINET  
36"W X 23.25"D X 35.5"H  
70-00221-00000000060

**OPEN STORAGE CABINETS**



12" OPEN STORAGE CABINET  
12"W X 23.25"D X 35.5"H  
70-00222-00000000060

24" OPEN STORAGE CABINET  
24"W X 23.25"D X 35.5"H  
70-00223-00000000060

36" OPEN STORAGE CABINET  
36"W X 23.25"D X 35.5"H  
70-00224-00000000060



P.O.S

# cabinets

## 24" DISPLAY CABINETS



24" P.O.S DISPLAY CABINET 1-DOOR, LEFT  
OPENING, LEFT + RIGHT SIDE MIRROR VITRINE  
24"W X 23.25"D X 35.5"H  
70-00226-00000000060

24" P.O.S DISPLAY CABINET 1-DOOR, LEFT  
OPENING, LEFT SIDE MIRROR VITRINE  
24"W X 23.25"D X 35.5"H  
70-00261-00000000060

24" P.O.S DISPLAY CABINET 1-DOOR, LEFT  
OPENING, RIGHT SIDE MIRROR VITRINE  
24"W X 23.25"D X 35.5"H  
70-00262-00000000060

## 36" DISPLAY CABINETS



36" P.O.S DISPLAY CABINET 2-DOOR,  
LEFT + RIGHT SIDE MIRROR VITRINE  
36"W X 23.25"D X 35.5"H  
70-00227-00000000060

36" P.O.S DISPLAY CABINET 2-DOOR,  
LEFT SIDE MIRROR VITRINE  
36"W X 23.25"D X 35.5"H  
70-00263-00000000060

36" P.O.S DISPLAY CABINET 2-DOOR,  
RIGHT SIDE MIRROR VITRINE  
36"W X 23.25"D X 35.5"H  
70-00264-00000000060

## 48" DISPLAY CABINETS



48" P.O.S DISPLAY CABINET 2-DOOR,  
LEFT + RIGHT SIDE MIRROR VITRINE  
48"W X 23.25"D X 35.5"H  
70-00299-00000000060

48" P.O.S DISPLAY CABINET 2-DOOR,  
LEFT SIDE MIRROR VITRINE  
48"W X 23.25"D X 35.5"H  
70-00300-00000000060

48" P.O.S DISPLAY CABINET 2-DOOR,  
RIGHT SIDE MIRROR VITRINE  
48"W X 23.25"D X 35.5"H  
70-00301-00000000060

P.O.S

# cabinets

● 24" DELI DISPLAY CABINETS



24" P.O.S DELI DISPLAY CABINET  
WITH DRAWER, FRONT OPENING  
24"W X 24"D X 41.5"H  
70-00228-00000000060

24" P.O.S DELI DISPLAY CABINET  
WITH DRAWER, BACK OPENING  
24"W X 24"D X 41.5"H  
70-00229-00000000060

● 36" DELI DISPLAY CABINETS



36" P.O.S DELI DISPLAY CABINET  
WITH DRAWER, FRONT OPENING  
36"W X 24"D X 41.5"H  
70-00230-00000000060

36" P.O.S DELI DISPLAY CABINET  
WITH DRAWER, BACK OPENING  
36"W X 24"D X 41.5"H  
70-00231-00000000060

CORNER CABINET



24" CORNER CABINET  
24"W X 23.25"D X 35.5"H  
70-00232-00000000020

# BACK WRAP cabinets

## 1-DOOR CABINETS



LEFT OPENING SHOWN

12" 1-DOOR BACK WRAP CABINET  
RIGHT OPENING  
12"W X 23.25"D X 35.5"H  
70-00237-00000000060

12" 1-DOOR BACK WRAP CABINET  
LEFT OPENING  
12"W X 23.25"D X 35.5"H  
70-00238-00000000060

24" 1-DOOR BACK WRAP CABINET  
RIGHT OPENING  
24"W X 23.25"D X 35.5"H  
70-00239-00000000060

24" 1-DOOR BACK WRAP CABINET  
LEFT OPENING  
24"W X 23.25"D X 35.5"H  
70-00240-00000000060

## 2-DOOR CABINETS



36" 2-DOOR BACK WRAP CABINET  
36"W X 23.25"D X 35.5"H  
70-00241-00000000060

## 1-DOOR SHALLOW CABINETS



LEFT OPENING SHOWN

12" 1-DOOR BACK WRAP SHALLOW CABINET  
RIGHT OPENING  
12"W X 12.5"D X 35.5"H  
70-00242-00000000060

12" 1-DOOR BACK WRAP SHALLOW CABINET  
LEFT OPENING  
12"W X 12.5"D X 35.5"H  
70-00243-00000000060

24" 1-DOOR BACK WRAP SHALLOW CABINET  
RIGHT OPENING  
24"W X 12.5"D X 35.5"H  
70-00244-00000000060

24" 1-DOOR BACK WRAP SHALLOW CABINET  
LEFT OPENING  
24"W X 12.5"D X 35.5"H  
70-00245-00000000060

## 2-DOOR SHALLOW CABINETS



36" 2-DOOR BACK WRAP SHALLOW CABINET  
36"W X 12.5"D X 35.5"H  
70-00246-00000000060

*NOTE*  
Front doors typically receive laminate to match companion units. Black & white refers to internal cabinet materials.

BACK WRAP  
**cabinets**

**DRAWER CABINETS**



24" DRAWER BACK WRAP CABINET  
24"W X 23.25"D X 35.5"H  
70-00247-00000000060

36" DRAWER BACK WRAP CABINET  
36"W X 23.25"D X 35.5"H  
70-00248-00000000060

**DRAWER SHALLOW CABINETS**



24" 2-DRAWER BACK WRAP SHALLOW CABINET  
24"W X 12.5"D X 35.5"H  
70-00277-00000000060

36" 2-DRAWER BACK WRAP SHALLOW CABINET  
36"W X 12.5"D X 35.5"H  
70-00269-00000000060

**PASS-THROUGH CABINETS**



24" PASS-THROUGH CABINET  
24"W X 18.875"D X 36"H  
70-00249-00000000060

36" PASS-THROUGH CABINET  
36"W X 18.875"D X 36"H  
70-00250-00000000060

**NOTE**

Front/external (in sales area) drawer faces typically receive laminate to match companion units. Black & white refers to internal cabinet materials (including drawer faces in B.O.H.).

P.O.S + BACK WRAP

# finishing panels

## SIDE COVER PANELS



### FRONT COVER PANEL

75" T X 33.5" H \*

70-00233-00000000020

### SIDE COVER PANEL

75" T X 24" L X 33.5" H

70-00234-00000000020

### SHORT SIDE COVER PANEL

75" T X 24" L X 27" H

SKU?

## COUNTER TOPS

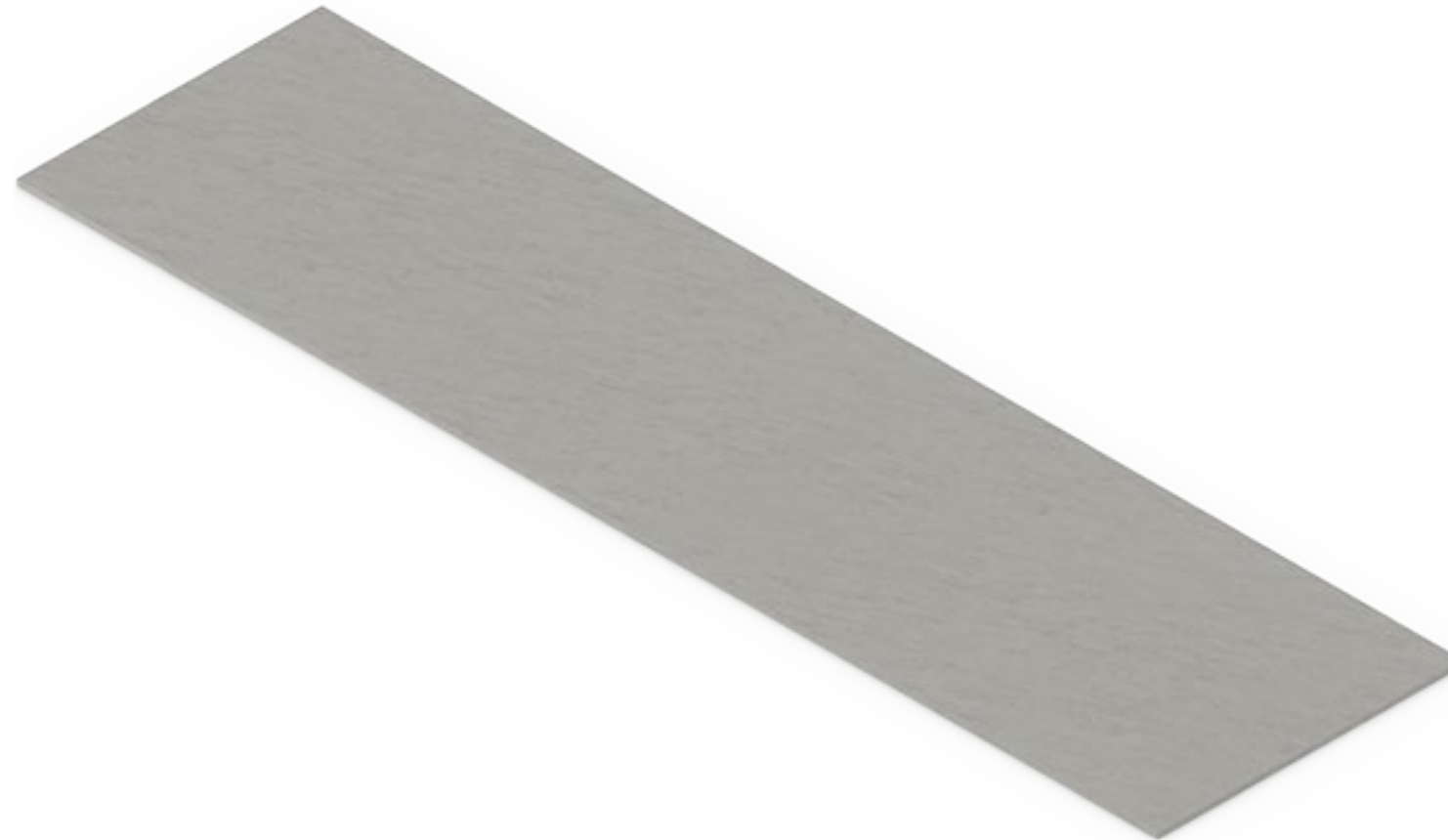

### SOLID SURFACE COUNTER TOP

5" T X 24" D \*

70-00253-00000000010

### LAMINATE COUNTER TOP

5" T X 24" D \*

70-00255-00000000020

### SOLID SURFACE SHALLOW COUNTER TOP

5" T X 13.5" D \*

70-00254-00000000010

### LAMINATE COUNTER SHALLOW TOP

.5" T X 13.5" D \*

70-00256-00000000020

NOTE

\* Length is custom to the required unit.

RECEPTION  
**cabinets**

**1-DOOR AGE GATE CABINET**



24" 1-DOOR RECEPTION CABINET  
RIGHT OPENING  
24"W X 24"D X 36"H  
70-00172-00000000070

24" 1-DOOR RECEPTION CABINET  
LEFT OPENING  
24"W X 24"D X 36"H  
70-00173-00000000070

**2-DOOR AGE GATE CABINET**



36" 2-DOOR RECEPTION CABINET  
36"W X 24"D X 36"H  
70-00174-00000000070



# lighting



COMPONENTS

LIGHTING

# wall system

## WALL SYSTEM POWER KIT

INCLUDES POWER TRACK AND TRANSFORMER

PERIMETER POWER KIT

70-00077-000000000000

\* REQUIRED FOR ALL WALL SYSTEM LIGHTING



## WALL SHELF LIGHTING KIT

INCLUDES MAGNETIC LED STRIP

24" MAGNETIC SHELF DOWN LIGHTING KIT

70-00017-000000000000

36" MAGNETIC SHELF DOWN LIGHTING KIT

70-00018-000000000000

48" MAGNETIC SHELF DOWN LIGHTING KIT

70-00108-000000000000

## WALL BOX LIGHTING KIT

INCLUDES MAGNETIC LED STRIP

24" MAGNETIC WALL BOX LIGHTING KIT

70-00025-000000000000

36" MAGNETIC WALL BOX LIGHTING KIT

70-00026-000000000000

## HEADER DOWN LIGHTING KIT

INCLUDES MAGNETIC LED STRIP

24" HEADER DOWN LIGHTING KIT

70-00051-000000000000

36" HEADER DOWN LIGHTING KIT

70-00052-000000000000

48" HEADER DOWN LIGHTING KIT

70-00133-000000000000

## HEADER SIGN LIGHTING KIT

INCLUDES LED PANEL

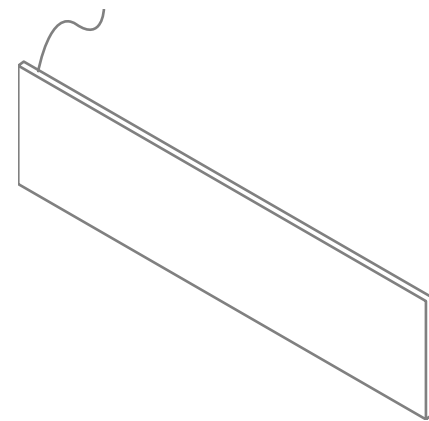

24" SHORT HEADER SIGN LIGHTING KIT

70-00049-000000000000

24" TALL HEADER SIGN LIGHTING KIT

70-00129-000000000000

36" SHORT HEADER SIGN LIGHTING KIT

70-00050-000000000000

36" TALL HEADER SIGN LIGHTING KIT

70-00130-000000000000

48" SHORT HEADER SIGN LIGHTING KIT

70-00131-000000000000

48" TALL HEADER SIGN LIGHTING KIT

70-00132-000000000000

LIGHTING

# table system

## DISPLAY BOX TABLE BASE LIGHTING KIT

INCLUDES LED PANEL, METAL LIGHT DIFFUSER, 36W DRIVER + CABLE MANAGEMENT TRAY

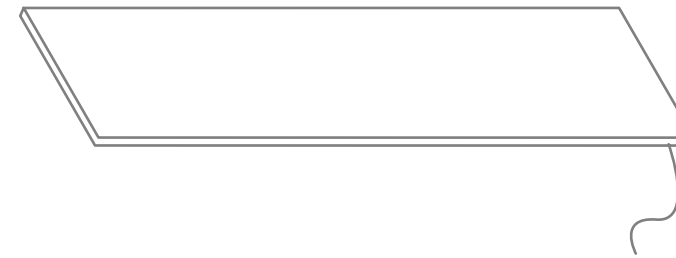

2'X2' DISPLAY BOX TABLE BASE LIGHTING KIT

70-00134-000000000060

2'X3' DISPLAY BOX TABLE BASE LIGHTING KIT

70-00135-000000000060

2'X4' DISPLAY BOX TABLE BASE LIGHTING KIT

70-00136-000000000060

3'X3' DISPLAY BOX TABLE BASE LIGHTING KIT

70-00137-000000000060

3'X4' DISPLAY BOX TABLE BASE LIGHTING KIT

70-00138-000000000060

## DISPLAY BOX TABLE DOWN LIGHTING KIT

INCLUDES 2 MAGNETIC LED STRIPS, 2 METAL LIGHT DIFFUSERS, 36W DRIVER + CABLE MANAGEMENT TRAY

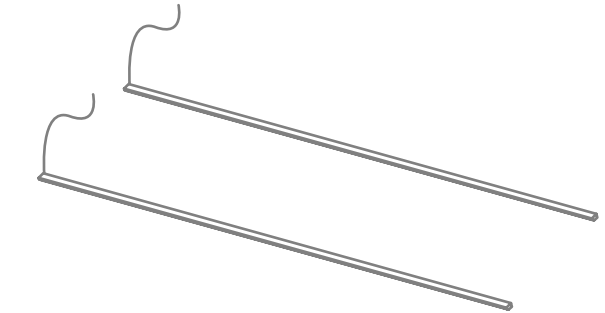

2' DISPLAY BOX TABLE DOWN LIGHTING KIT

70-00309-000000000000

3' DISPLAY BOX TABLE DOWN LIGHTING KIT

70-00310-000000000000

4' DISPLAY BOX TABLE DOWN LIGHTING KIT

70-00311-000000000000

NOTE

Table-mounted lighting requires floor power outlets and are powered by a visible cord.



LIGHTING

# vitrones

## VITRINE BASE LIGHTING KIT

INCLUDES LED PANEL, METAL LIGHT DIFFUSER + 36W DRIVER

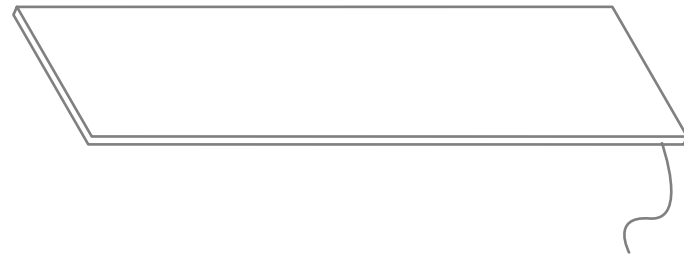

1'X2' VITRINE BASE LIGHTING KIT  
70-00139-000000000000

1'X3' VITRINE BASE LIGHTING KIT  
70-00140-000000000000

2'X2' VITRINE BASE LIGHTING KIT  
70-00141-000000000000

2'X3' VITRINE BASE LIGHTING KIT  
70-00142-000000000000

2'X4' VITRINE BASE LIGHTING KIT  
70-00143-000000000000

3'X3' VITRINE BASE LIGHTING KIT  
70-00144-000000000000

3'X4' VITRINE BASE LIGHTING KIT  
70-00145-000000000000

## VITRINE DOWN LIGHTING KIT

INCLUDES 2 MAGNETIC LED STRIPS, 2 METAL LIGHT DIFFUSERS + 36W DRIVER

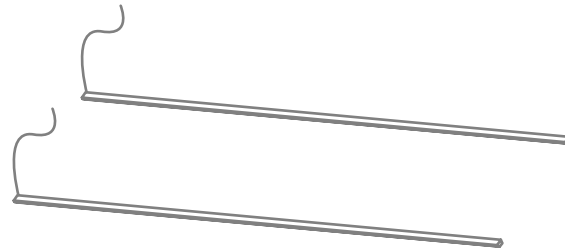

2' MAGNETIC VITRINE DOWN LIGHTING KIT  
70-00146-000000000000

3' MAGNETIC VITRINE DOWN LIGHTING KIT  
70-00147-000000000000

4' MAGNETIC VITRINE DOWN LIGHTING KIT  
70-00148-000000000000

## FLOOR POWER KIT

POWER STRIP WITH COILED CORD USED FOR TABLES WHEN LIGHTING KITS ARE REQUIRED

FLOOR POWER KIT, BLACK COIL  
70-00314-000000000000

FLOOR POWER KIT, WHITE COIL  
70-00315-000000000000

LIGHTING

# cash wrap

## CASH WRAP DISPLAY CABINET BASE LIGHTING KIT

INCLUDES LED PANEL, METAL LIGHT DIFFUSER, 36W DRIVER + POWER STRIP

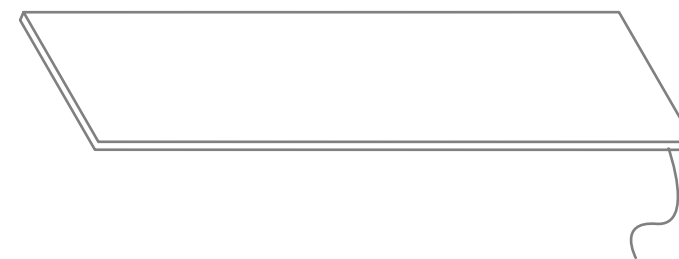

24" P.O.S DISPLAY CABINET BASE LIGHTING KIT  
70-00149-000000000000

36" P.O.S DISPLAY CABINET BASE LIGHTING KIT  
70-00150-000000000000

48" P.O.S DISPLAY CABINET BASE LIGHTING KIT  
70-00307-000000000000

## CASH WRAP DISPLAY CABINET DOWN LIGHTING KIT

INCLUDES 2 MAGNETIC LED STRIPS, 2 METAL LIGHT DIFFUSERS, 36W DRIVER + POWER STRIP WITH COILED CORD (BLACK OR WHITE)

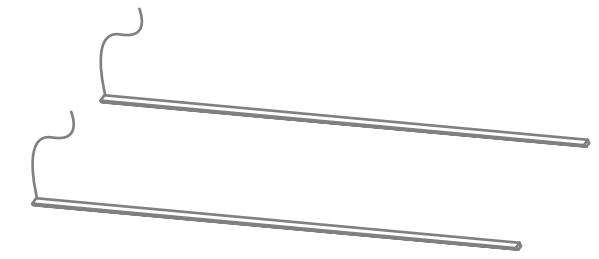

24" DISPLAY CABINET DOWN LIGHTING KIT  
70-00312-000000000000

36" DISPLAY CABINET DOWN LIGHTING KIT  
70-00313-000000000000

48" DISPLAY CABINET DOWN LIGHTING KIT  
70-00308-000000000000

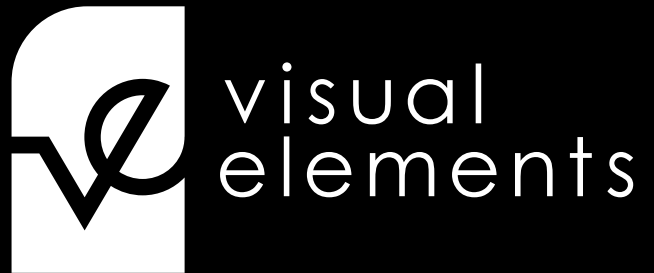

# the module system

**FOR MORE INFORMATION PLEASE CONTACT**

[info@visual-elements.ca](mailto:info@visual-elements.ca)

(905) 761-5222

[visual-elements.ca](http://visual-elements.ca)